

Lid Stays

Part Number	Description	Material	Finish
J2007	right hand	steel	zinc plated
J2008	left hand	steel	zinc plated

▶ .122 [3.10] thick steel

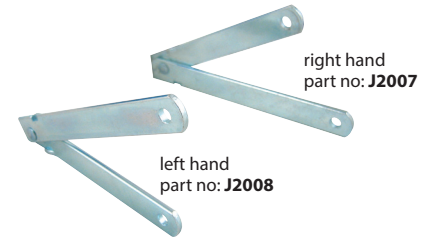
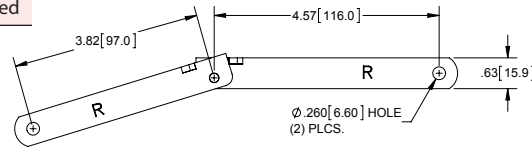

Lid Stays with Mounting Brackets

Part Number	Description	Material	Finish
J2005 ‡	right hand	steel	brass plated & lacquered
NEW J2005ZN	right hand	steel	zinc plated
J2006 ‡	left hand	steel	brass plated & lacquered
NEW J2006ZN	left hand	steel	zinc plated

▶ .059 [1.50] thick steel

▶ parts no. J2005 & J2006 do not have spep.com logo stamp

‡ these parts are non-stock

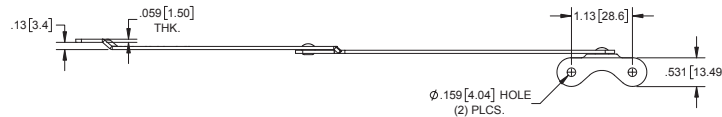
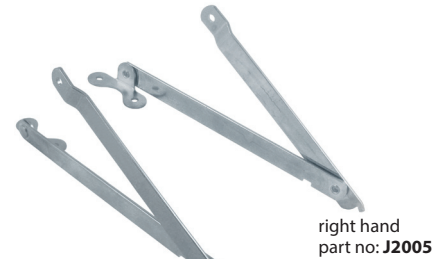
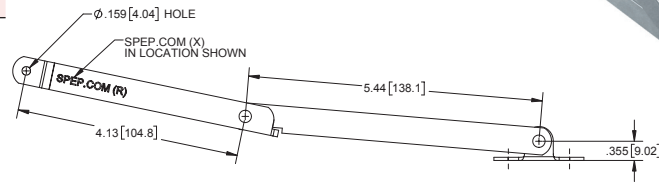
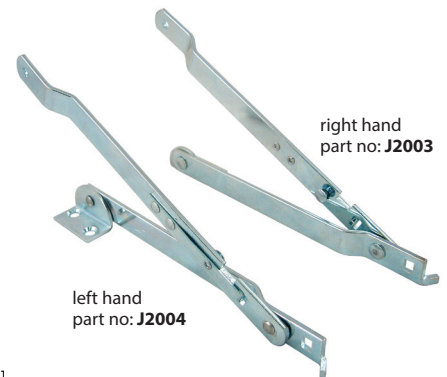
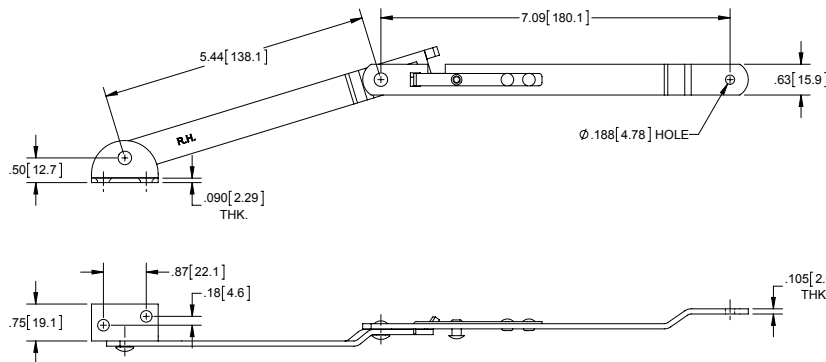

Table Braces

Part Number	Description	Material	Finish
J2003	right hand	steel	zinc plated
J2004	left hand	steel	zinc plated



Lid Stays

Part Number	Description	Material	Finish
TM-81-2R	right hand	304SS	barrel polished
TM-81-2L	left hand	304SS	barrel polished

